

Samsung GT-i9300 Galaxy S3 Schematic!

MIDAS_REV1.1

www.Mobile-Files.com

www.witesomtesla.com

- sheet 01 : THIS PAGE
- sheet 02 : 2G / 3G RF, TRANCEIVER
- sheet 03 : GPS, FM, BT, WIFI, NFC, SENSOR
- sheet 04 : CP(XMM6262), MICRO SD, SIM
- sheet 05 : AP CHIP, MEMORY
- sheet 06 : AP PMIC, IF PMIC
- sheet 07 : AUDIO
- sheet 08 : CAM, LCD, MHL
- sheet 09 : 1st. PCB PLACEMENT DRAWING
- sheet 10 : 2nd. PCB PLACEMENT DRAWING

Engineer	Wites OM Tesla		
Drawn by	Wites	Sheet	001
App. Code	MIDAS		
Doc. No. Code			
App. No. Code			
Doc. Code	001	Drawing Number	Sheet 1/4

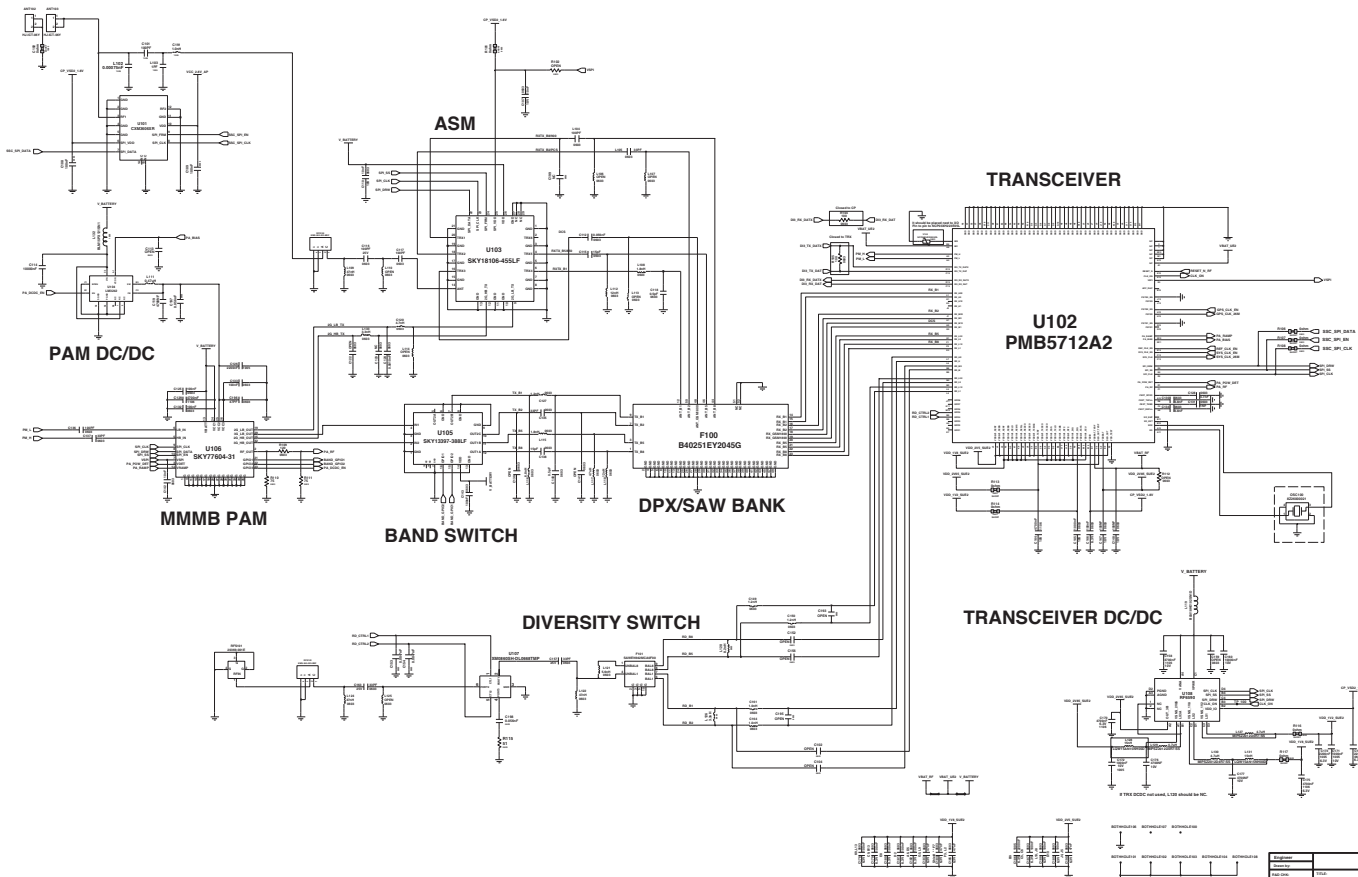

GPS (BCM47511)

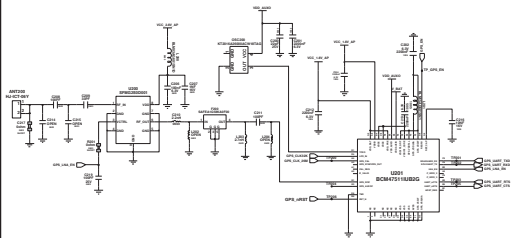

BT/WIFI/FM (SWB-B53 --- BCM4334 MODULE)

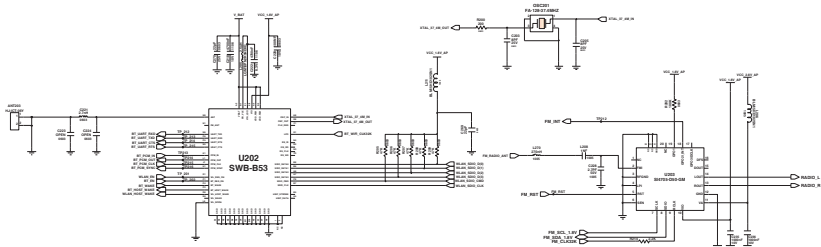

SENSORS

Magnetic Sensor

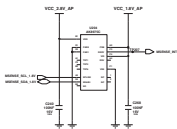

6 Axis Sensor (GYRO,ACCEL)

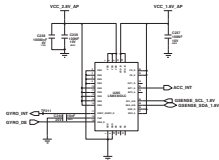

Barometer Sensor

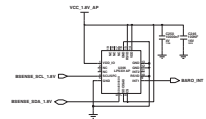

NFC

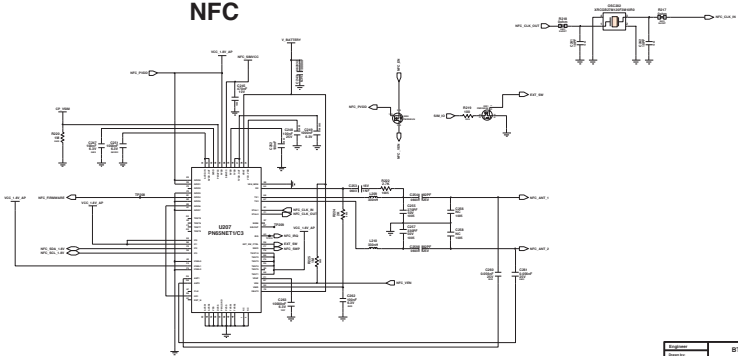

Part Number	BT/WIFI, FM, GPS
Revision	001
File Name	GT-9300_REV1.1
Author	
Check Date	
Check Name	
Check Date	
Check Name	

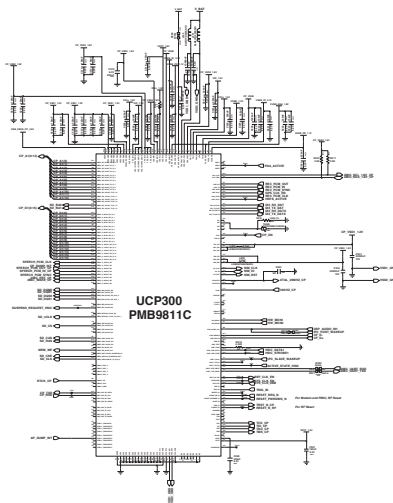

moviNand + DDR

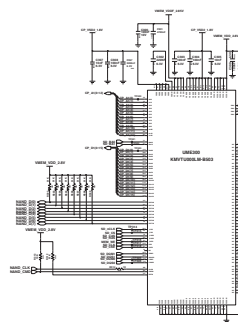

10GB	
32GB	
64GB	

EU	
ALU	
IN	

SIM / SD CON

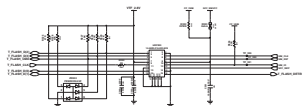

Light-Guide LED Driver

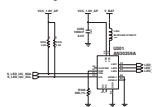

CP/AP JTAG

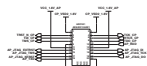

PCB JTAG



MDAS_REV05

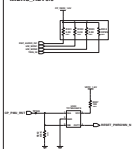

AP_PART

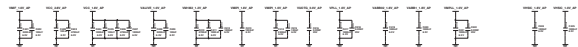

Power On @ Sleep

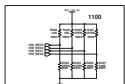
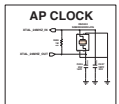

HW Version Check
HW Revision Setting

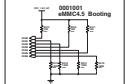

IROM BOOT
OneTimeROM (0x1A / 0x1A0000)

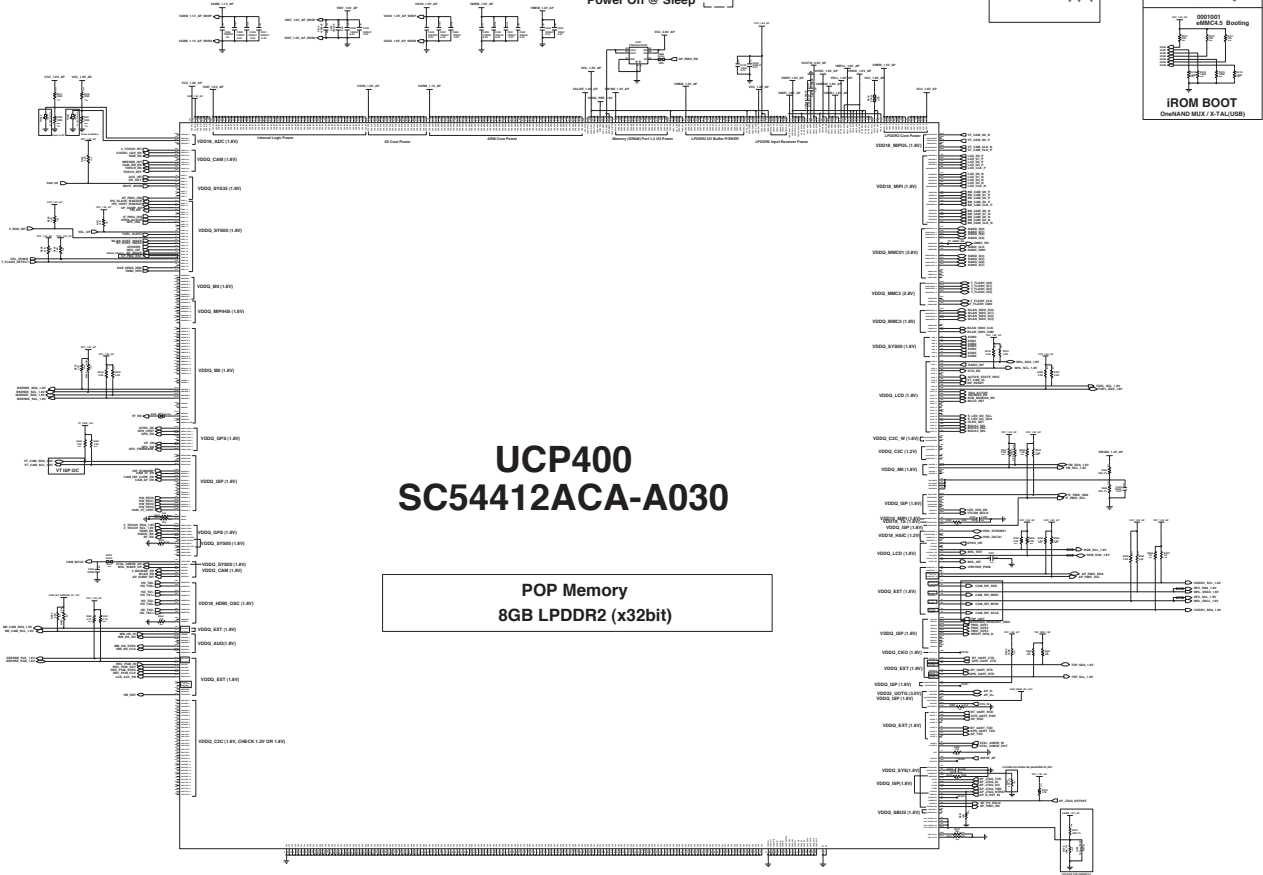

UCP400
SC54412ACA-A030

POP Memory
8GB LPDDR2 (x32bit)

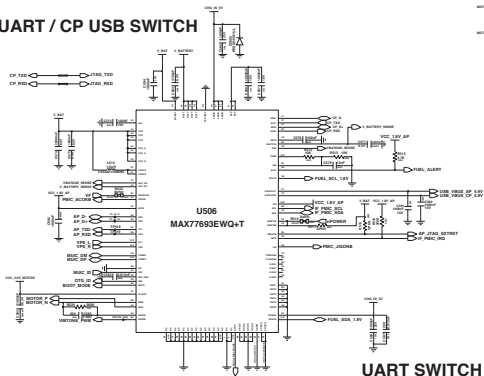
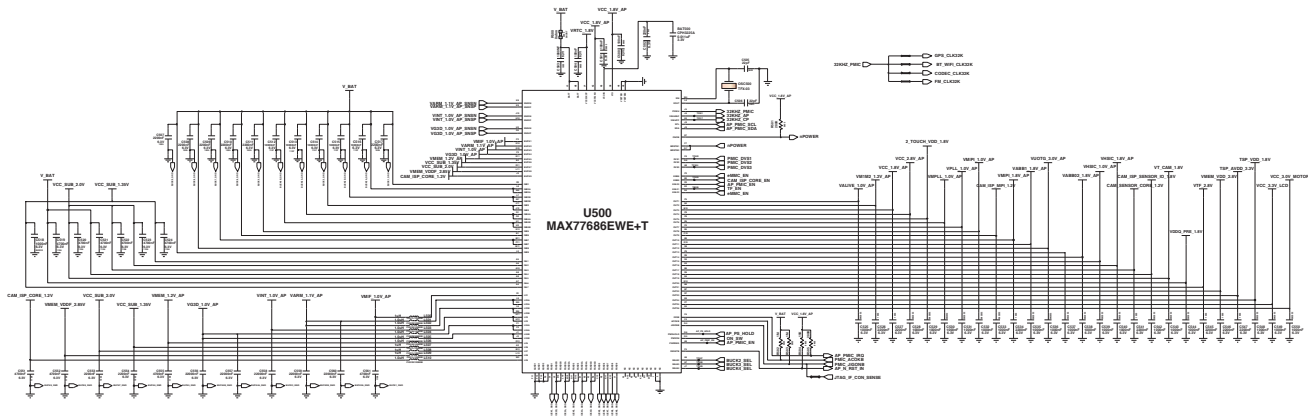

	LOW	HIGH
USB_SEL	IF_TXDRXD	CP_D+D-
UART_SEL	CP_TXDRXD	AP_TXDRXD

MOT CONTACT



HOME KEY

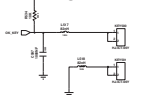

WIRELESS CHARGING SWITCH

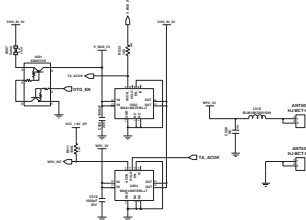

Battery Connector

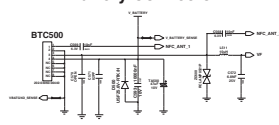

CAM FLASH/TORCH LED

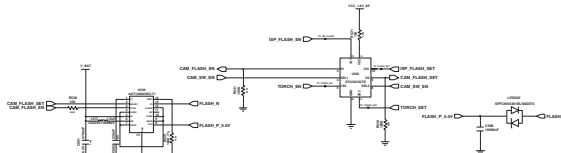

PH8C	
Part Number	PH8C
Revision	1.0
Release Date	2014.08.01
Product Name	GT-89300_REV1.1
Manufacturer	PHILIPS
Customer	

Audio PART

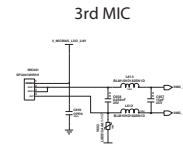
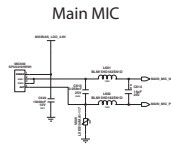
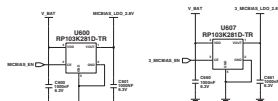

Audio Codec

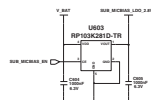
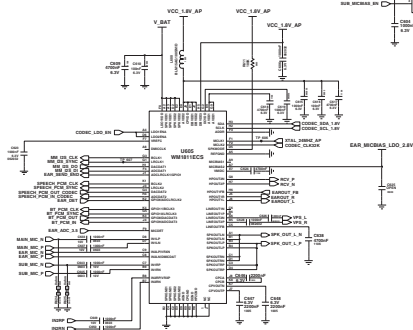

Two - MIC chip

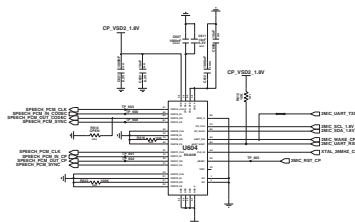

Sub MIC

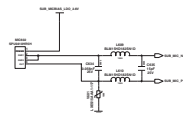

RCV + SVC LED + VOL KEY

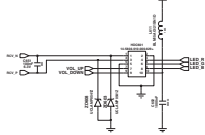
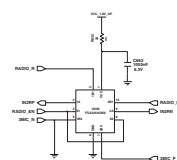

Ear MIC

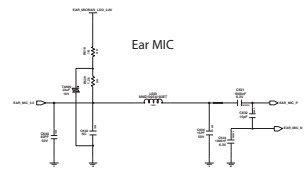

TOUCH / DOME FPCB

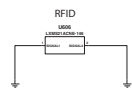
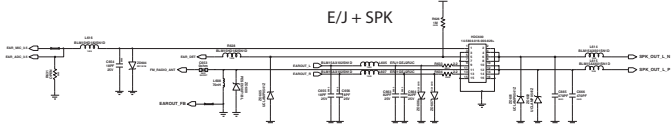

POWER / HOLD KEY

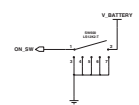

Part Number	AUDIO
Revision	1.0
Created Date	2010/01/15
Created By	GT-9300_REV1.1
Checked By	
Approved By	

Top PCB Layout

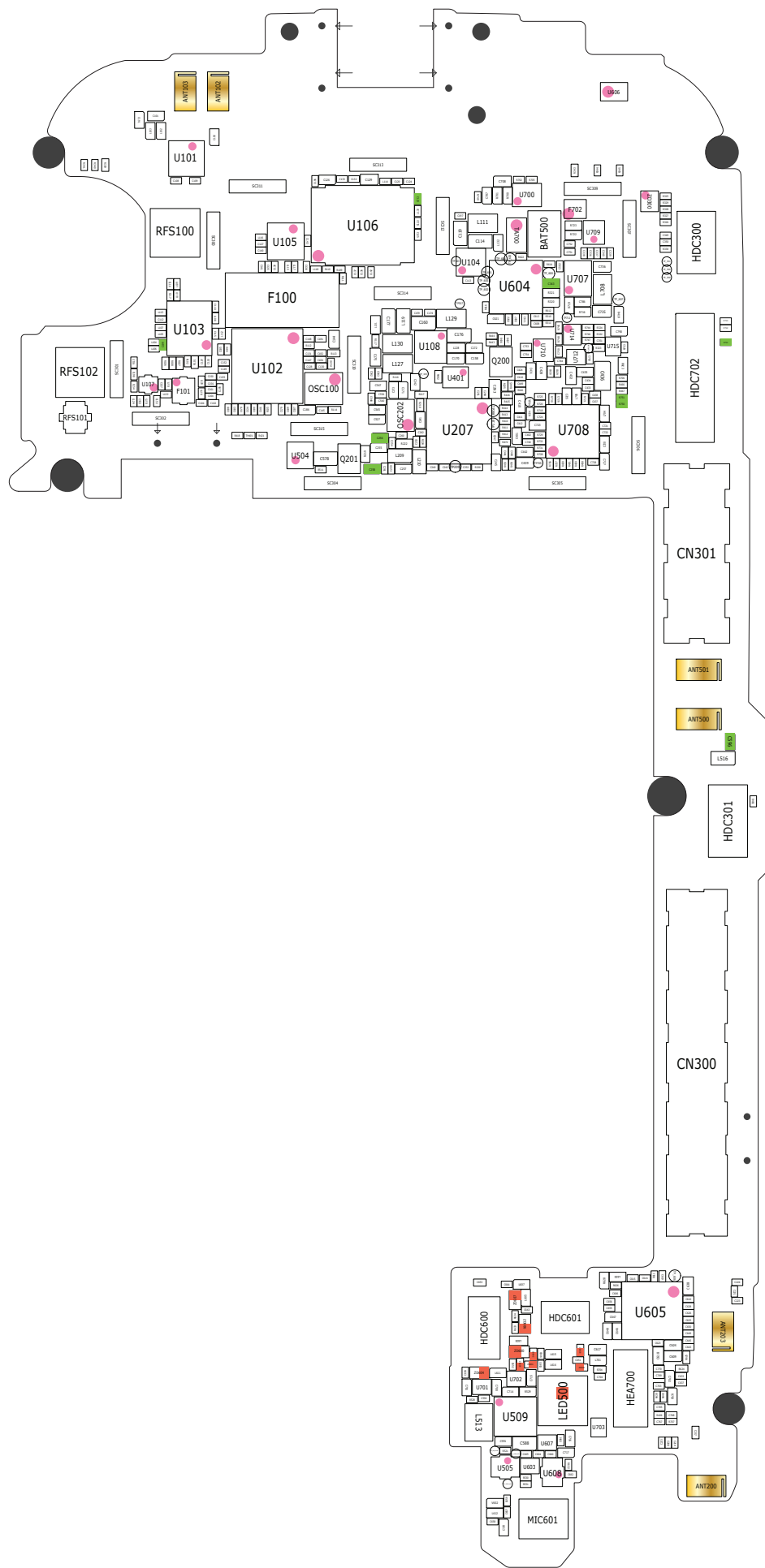

Bottom PCB Layout

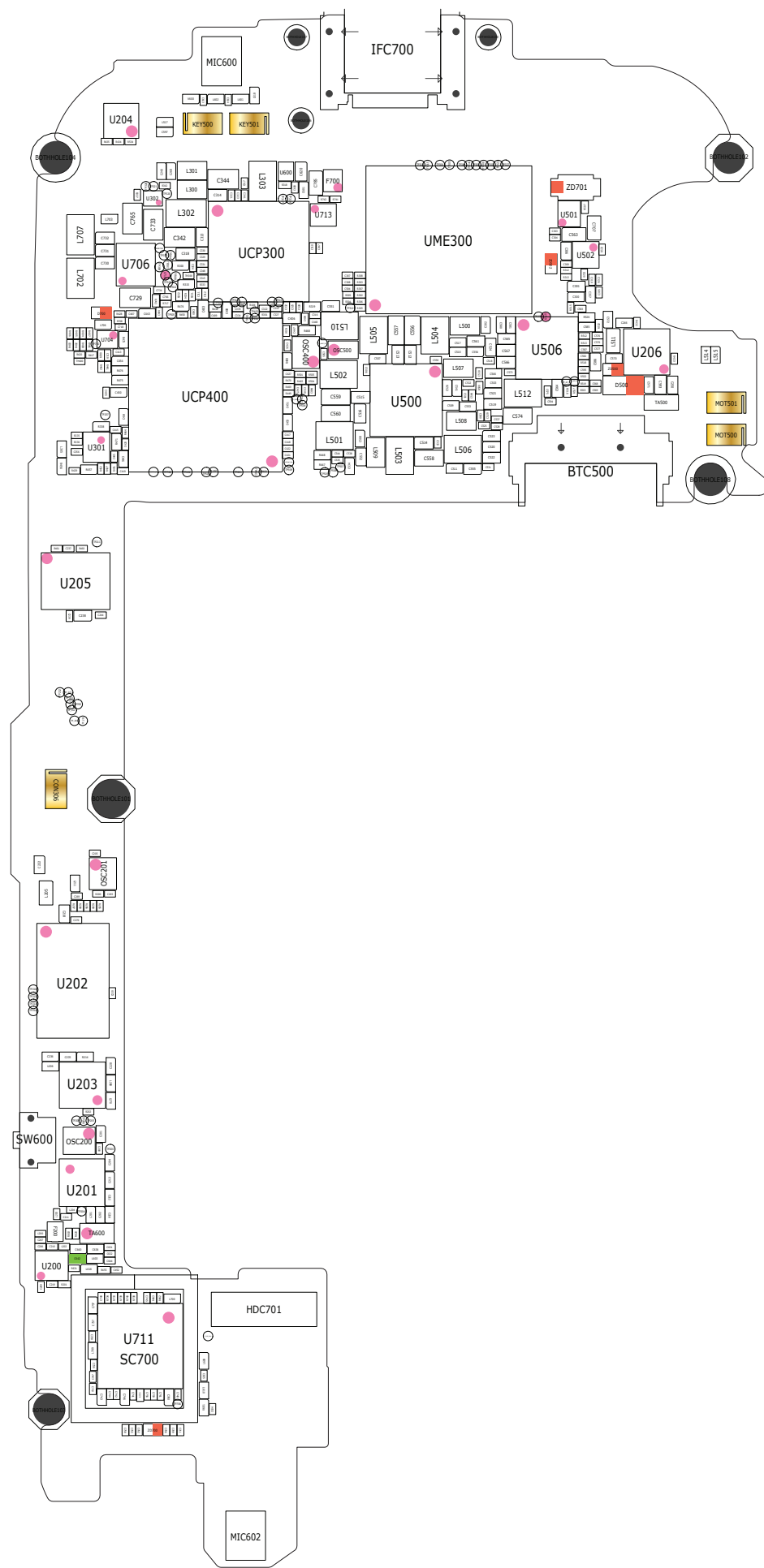

8-2-1. Top

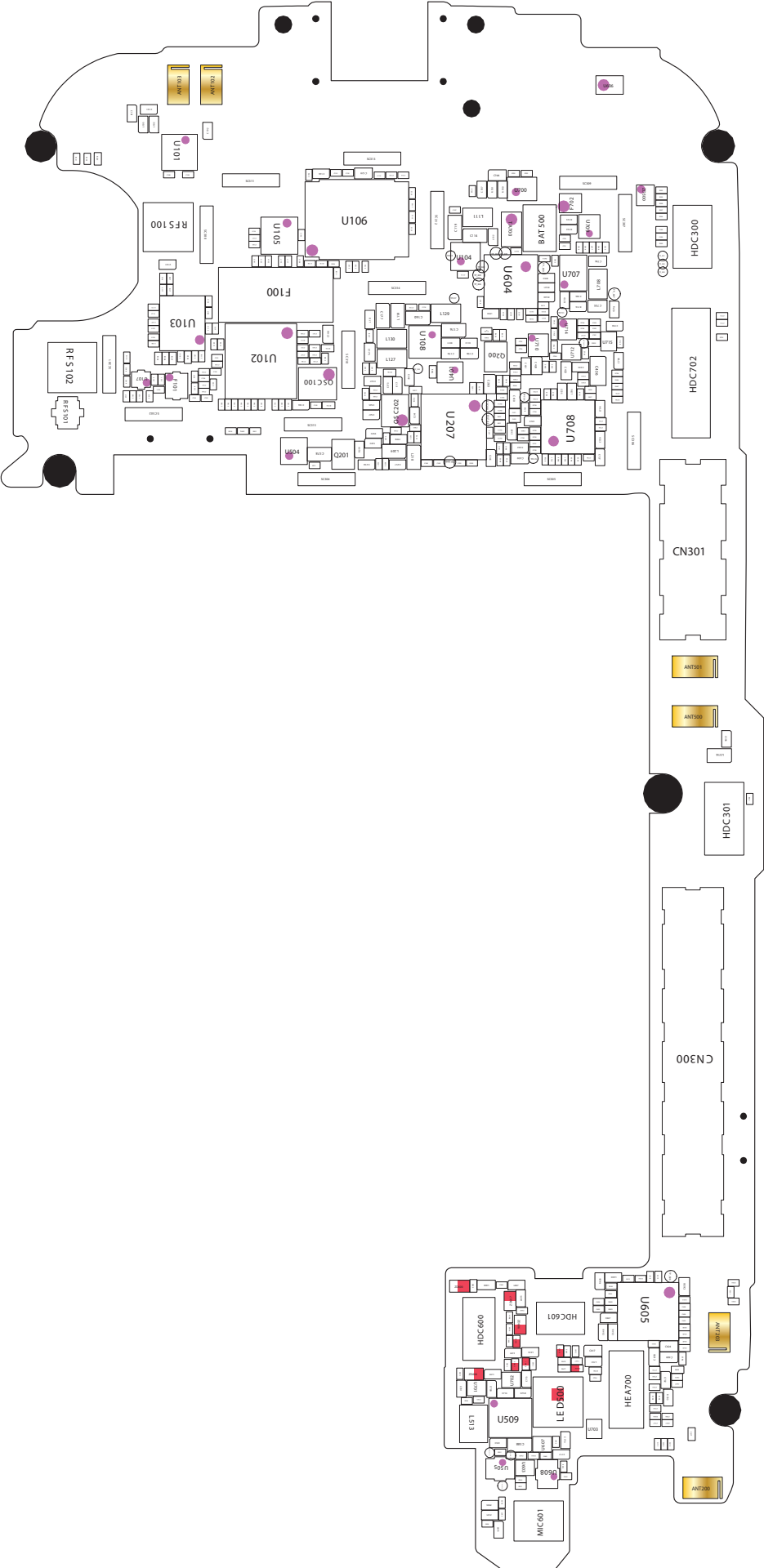

8-2-2. Bottom

