

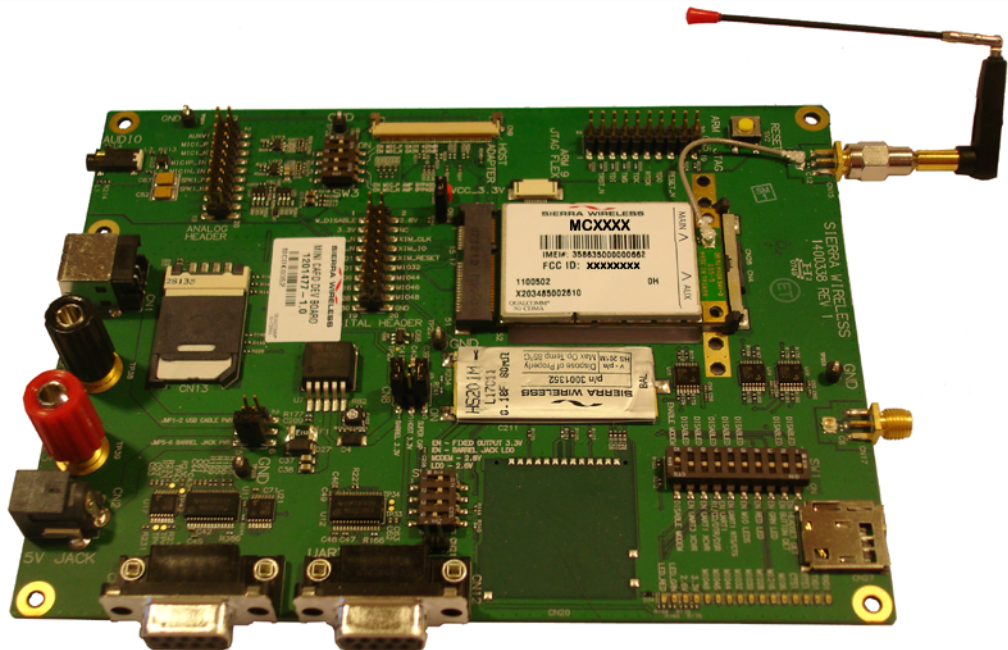

AirPrime MC Series Dev Kit

Quick Start Guide



SIERRA
WIRELESS

2130705
Rev 1.5

Important Notice

Due to the nature of wireless communications, transmission and reception of data can never be guaranteed. Data may be delayed, corrupted (i.e., have errors) or be totally lost. Although significant delays or losses of data are rare when wireless devices such as the Sierra Wireless modem are used in a normal manner with a well-constructed network, the Sierra Wireless modem should not be used in situations where failure to transmit or receive data could result in damage of any kind to the user or any other party, including but not limited to personal injury, death, or loss of property. Sierra Wireless accepts no responsibility for damages of any kind resulting from delays or errors in data transmitted or received using the Sierra Wireless modem, or for failure of the Sierra Wireless modem to transmit or receive such data.

Safety and Hazards

Do not operate the Sierra Wireless modem in areas where blasting is in progress, where explosive atmospheres may be present, near medical equipment, near life support equipment, or any equipment which may be susceptible to any form of radio interference. In such areas, the Sierra Wireless modem **MUST BE POWERED OFF**. The Sierra Wireless modem can transmit signals that could interfere with this equipment.

Do not operate the Sierra Wireless modem in any aircraft, whether the aircraft is on the ground or in flight. In aircraft, the Sierra Wireless modem **MUST BE POWERED OFF**. When operating, the Sierra Wireless modem can transmit signals that could interfere with various onboard systems.

Note: Some airlines may permit the use of cellular phones while the aircraft is on the ground and the door is open. Sierra Wireless modems may be used at this time.

The driver or operator of any vehicle should not operate the Sierra Wireless modem while in control of a vehicle. Doing so will detract from the driver or operator's control and operation of that vehicle. In some states and provinces, operating such communications devices while in control of a vehicle is an offence.

Limitation of Liability

The information in this manual is subject to change without notice and does not represent a commitment on the part of Sierra Wireless. SIERRA WIRELESS AND ITS AFFILIATES SPECIFICALLY DISCLAIM LIABILITY FOR ANY AND ALL DIRECT, INDIRECT, SPECIAL, GENERAL, INCIDENTAL, CONSEQUENTIAL, PUNITIVE OR EXEMPLARY DAMAGES INCLUDING, BUT NOT LIMITED TO, LOSS OF PROFITS OR REVENUE OR ANTICIPATED PROFITS OR REVENUE ARISING OUT OF THE USE OR INABILITY TO USE ANY SIERRA WIRELESS PRODUCT, EVEN IF SIERRA WIRELESS AND/OR ITS AFFILIATES HAS BEEN ADVISED OF THE POSSIBILITY OF SUCH DAMAGES OR THEY ARE FORESEEABLE OR FOR CLAIMS BY ANY THIRD PARTY.

Notwithstanding the foregoing, in no event shall Sierra Wireless and/or its affiliates aggregate liability arising under or in connection with the Sierra Wireless product, regardless of the number of events, occurrences, or claims giving rise to liability, be in excess of the price paid by the purchaser for the Sierra Wireless product.

Patents

Portions of this product may be covered by some or all of the following US patents:

5,515,013	5,629,960	5,845,216	5,847,553	5,878,234	5,890,057
5,929,815	6,169,884	6,191,741	6,199,168	6,339,405	6,359,591
6,400,336	6,516,204	6,561,851	6,643,501	6,653,979	6,697,030
6,785,830	6,845,249	6,847,830	6,876,697	6,879,585	6,886,049
6,968,171	6,985,757	7,023,878	7,053,843	7,106,569	7,145,267
7,200,512	7,295,171	7,287,162	D442,170	D459,303	D599,256
D560,911					

and other patents pending.

This product includes technology licensed from QUALCOMM® 3G.

Manufactured or sold by Sierra Wireless or its licensees under one or more patents licensed from InterDigital Group.

Copyright

©2010 Sierra Wireless. All rights reserved.

Trademarks

AirCard® and Watcher® are registered trademarks of Sierra Wireless. Sierra Wireless™, AirPrime™, AirLink™, AirVantage™ and the Sierra Wireless logo are trademarks of Sierra Wireless.

Windows® and Windows Vista® are registered trademarks of Microsoft Corporation.

Macintosh and Mac OS are registered trademarks of Apple Inc., registered in the U.S. and other countries.

QUALCOMM® is a registered trademark of QUALCOMM Incorporated. Used under license.

Other trademarks are the property of their respective owners.

Contact Information

Sales Desk:	Phone:	1-604-232-1488
	Hours:	8:00 AM to 5:00 PM Pacific Time
	E-mail:	sales@sierrawireless.com
Post:	Sierra Wireless 13811 Wireless Way Richmond, BC Canada V6V 3A4	
Fax:	1-604-231-1109	
Web:	www.sierrawireless.com	

Consult our website for up-to-date product descriptions, documentation, application notes, firmware upgrades, troubleshooting tips, and press releases:

www.sierrawireless.com

Revision History

Revision number	Release date	Changes
1.2	Feb 2009	Newest UDK board; revised software installation procedure
1.3	Mar 2009	Added MC5728V. Added a column for MC5727V to Table 2-6 on page 22 . Removed references to MC5720, MC5725/MC5725V. Removed QUALCOMM patents from preface.
1.4	Jul 2009	Added MC8700. Removed references to MC8755, MC8755V, MC8765V, MC8785V. Updated Table 2-6, Dev Kit—Module signal map, on page 22
1.5	Apr 2010	Added MC8201 and MC8795V. New template/branding.



Contents

Introduction	9
Required equipment	10
Setup and Installation	13
Hardware setup	13
Insert a SIM card (UMTS Mini Cards only)	13
Insert the Mini Card	15
Connect the antenna(s)	16
Connect the power supply and USB cable	17
Remove/replace the Mini Card	17
Connect the Dev Kit and host device using a Mini Card Host Extender ..	17
Configure the Mini Card	18
Install / update Mini Card drivers and Watcher	22
Download CDMA installer package	22
Download UMTS installer package	23
Install CDMA or UMTS software	23
Schematic diagram	25
Bill of Materials	27

1: Introduction

This quick start guide explains how to set up the hardware and software components of Sierra Wireless' PCI Express Mini Card Dev Kit for use with the modules listed in [Table 1-1](#).

Table 1-1: Supported AirPrime Mini Cards^a

Network	Mini Cards
CDMA (MC57xx)	MC5727 MC5727V MC5728V
UMTS (MC8xxx)	MC8201 MC8700 MC8775 MC8775V MC8780 MC8781 MC8790 MC8790V MC8791V MC8792V MC8795V

- a. Throughout this document, MC57xx and MC8xxx refer to the listed suites of CDMA and UMTS Mini Cards respectively.

The Dev Kit will also be used for forthcoming CDMA and UMTS Mini Card modules. (Older Mini Cards may also be supported.)

Required equipment

Table 1-2 details the items required to begin using the Dev Kit in your development environment. If any items are missing from the Dev Kit, contact your Sierra Wireless representative.

Table 1-2: Required equipment











Item	Included in Dev Kit	Details
Drivers & Watcher software	No	<p>Watcher software and Mini Card device drivers for the following operating systems may be downloaded from www.sierrawireless.com/minicard:</p> <ul style="list-style-type: none"> Windows XP Pro (SP3) and higher Windows Vista (SP1) and higher <p>Registration is required to download these and other files.</p>
	No	The Dev Kit supports the Mini Cards listed in Table 1-1 on page 9 (purchased separately).
	Yes	<p>The antenna kit includes 2 each of:</p> <ul style="list-style-type: none"> Antenna Antenna connector Sample / replacement Molex connector Connecting wire
	Yes	
	Yes	
	Yes	The Mini Card is inserted into the Dev Kit for testing and development.

Table 1-2: Required equipment (Continued)

Item	Included in Dev Kit	Details
	Yes	Universal power supply, suitable for both 120 V and 240 V
	Yes	D-sub9 (male) to D-sub9 (female)
	Yes	Standard USB-A to USB-B cable
	No	(UMTS only) You need to supply a SIM/USIM with an active account for use with UMTS Mini Cards.
	Yes	Together, these are used to connect a Mini Card to a laptop via the Dev Kit.
	Yes	

2: Setup and Installation

To begin using the Dev Kit with your development system, set up your hardware and software:

- Hardware setup
 - [Insert a SIM card \(UMTS Mini Cards only\)](#) on page 13
 - [Insert the Mini Card](#) on page 15
 - [Connect the antenna\(s\)](#) on page 16
 - [Connect the power supply and USB cable](#) on page 17
 - [Connect the Dev Kit and host device using a Mini Card Host Extender](#) on page 17
- Software setup (CDMA)
 - [Install / update Mini Card drivers and Watcher](#) on page 22

Hardware setup

Insert a SIM card (UMTS Mini Cards only)

Note: Throughout this document, 'SIM' refers to 'SIM' and 'USIM'.

To use a UMTS Mini Card (MC8xxx), you need to install:

- A live SIM card (with an active account), *or*
- A test SIM card for use with a call box (for example, an Agilent 8960 or Rohde&Schwarz CMU200)

To install the SIM card:

1. Place the Dev Kit face-up (as shown)—the SIM slot is on the left side beside the USB plug and the black banana plug.

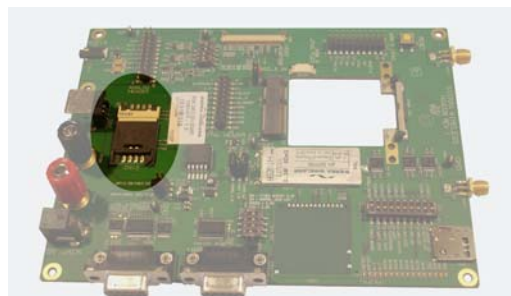

Figure 2-1: SIM slot location

2. Open the SIM casing—push the SIM slot cover into the ‘OPEN’ position (in the direction of the ANALOG HEADER), and then lift it.

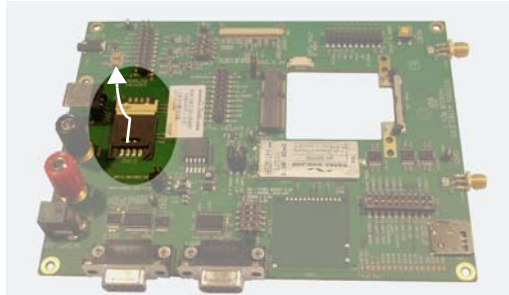

Figure 2-2: Opening the SIM cover

3. Insert the SIM card into the cover with its circuitry face-down—note the location of the notched corner of the card in the following image.

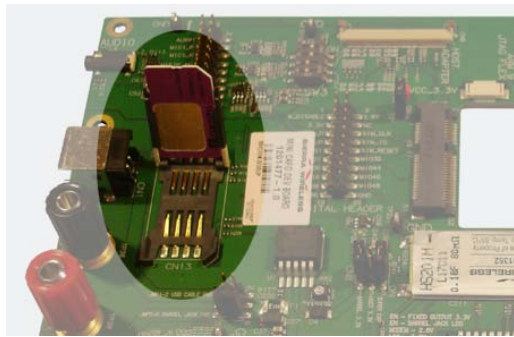

Figure 2-3: Inserting a SIM into the open cover

4. Lower the SIM slot cover—the cover (with the card inside) will be slightly raised (not making contact with the board).
5. Gently press down on the cover and then slide the slot cover under the connector base latches into the ‘CLOSED’ position—the cover locks into place.



Figure 2-4: SIM inserted with cover closed

Insert the Mini Card

After inserting the SIM card, insert the Mini Card:

1. Place the Dev Kit face-up (as shown)—the Mini Card slot is in the top right corner.

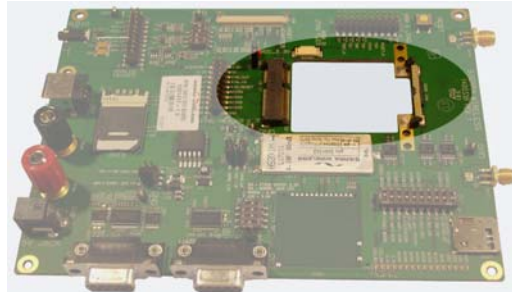

Figure 2-5: Mini Card slot

2. Hold the Mini Card at the screw holes and slide it into the Dev Kit's Mini Card slot at a 45° angle (inserting it 'flat' may damage the module's contacts and wear out the host connector).



Figure 2-6: Inserting a Mini Card

3. Push the free end of the Mini Card down until it clicks into the black MINIPCI-E latch.



Figure 2-7: Locking a Mini Card into the Dev Kit

Connect the antenna(s)

After installing the Mini Card, connect the supplied antenna(s) to the Dev Kit (some Mini Cards include both a main and an auxiliary (diversity/gps) antenna):

1. Place the Dev Kit face-up. The antenna connectors are on the right side near the top.
2. Screw the silver adapter onto the Dev Kit's main antenna connector.



Figure 2-8: Connecting the antenna adapter

3. Connect the Mini Card's main antenna to the Dev Kit's main antenna connector using the gray wire provided—press down lightly on the connector ends. (The first few times you use these connectors, they may be quite snug—press straight down on the end to get a secure connection.)



Figure 2-9: Connecting the antenna wire

4. Connect the antenna to the adapter. (The first few times you attach the antenna, it may be quite snug.)



Figure 2-10: Connecting the antenna

5. If your Mini Card supports a second antenna (diversity or gps), repeat [Step 2–Step 4](#) for the second antenna.

Connect the power supply and USB cable

To install the power supply and USB cable:

1. Place the Dev Kit face-up.
2. Insert one end of the USB cable into the USB connector (beside the SIM slot)—you will connect the other end to your development computer later (DO NOT connect it yet).
3. Insert the power supply into the Dev Kit's power supply connector (below the red banana plug, to the left of the UART1 connector)—the other end connects to a standard power outlet.

Remove/replace the Mini Card

When you want to remove or replace the Mini Card:

1. Place the Dev Kit face-up.
2. Remove the connecting wire(s) from the Mini Card's antenna(s)—use the connector tool, hook it under the RF connector and pull straight up.

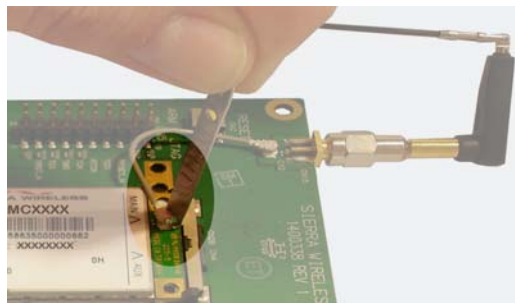

Figure 2-11: Removing the antenna wire

3. Holding the Dev Kit firmly in place, pull both arms of the MINIPCI-E latch at the same time toward the antenna connectors to release the module.
4. Pull the Mini Card out of the slot at a 45° angle.

Connect the Dev Kit and host device using a Mini Card Host Extender

To test the Mini Card integrated with the host device, use the Mini Card Host Extender and flat flex cable to connect the Dev Kit board and the host device:

1. Prepare the Dev Kit as normal—insert the SIM (for UMTS modems), insert the Mini Card, and attach the antenna. (You can do these steps at any time in this procedure.)
2. Insert the Mini Card Host Extender in your host device in the same way that you would insert the actual Mini Card.

Note: For simplicity, the images in this example show the Mini Card Host Extender unattached.

3. Insert one end of the flat flex cable (pins facing up) into any of the three connectors on the Mini Card Host Extender:
 - a. Push the cable forward, between the tabs of the brown clip on the connector. As you move the cable forward, you will feel some slight resistance as it moves into the connector and the clip tilts slightly upward.

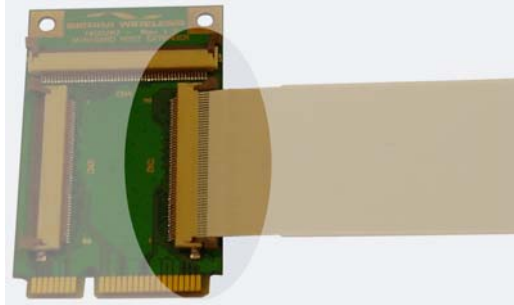

Figure 2-12: Attaching a host extender to a Mini Card

- b. When the cable is seated firmly in the connector, push down on the arms of the brown clip to lock the connector in place.
4. Insert the other end of the flat flex cable into connector CN9 on the Dev Kit board using the same method.

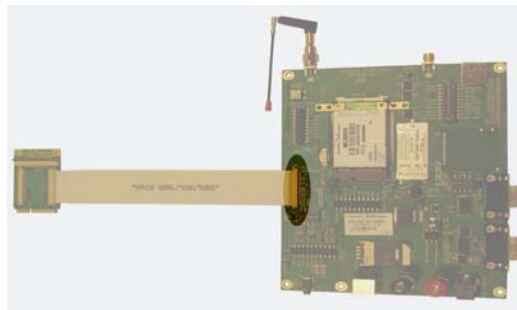

Figure 2-13: Attaching a host extender to the Dev Kit

To disconnect the flat flex cable from the Mini Card Host Extender or Dev Kit board:

1. Pull up on both arms of the brown clip on the connector at the same time to release the cable.
2. Pull the flat flex cable straight out of the connector.

Configure the Mini Card

The Dev Kit includes several switches and jumpers that you can use to configure the Mini Card's operation, as detailed in [Table 2-1](#) on page 19 through [Table 2-5](#) on page 21, and [Figure 2-15](#) on page 21. For a detailed schematic of the kit, see [Schematic diagram](#) on page 25.

Note: Some Dev Kit features are available for certain Mini Cards only. For example, the Audio and UART features are only available for voice-enabled Mini Cards.

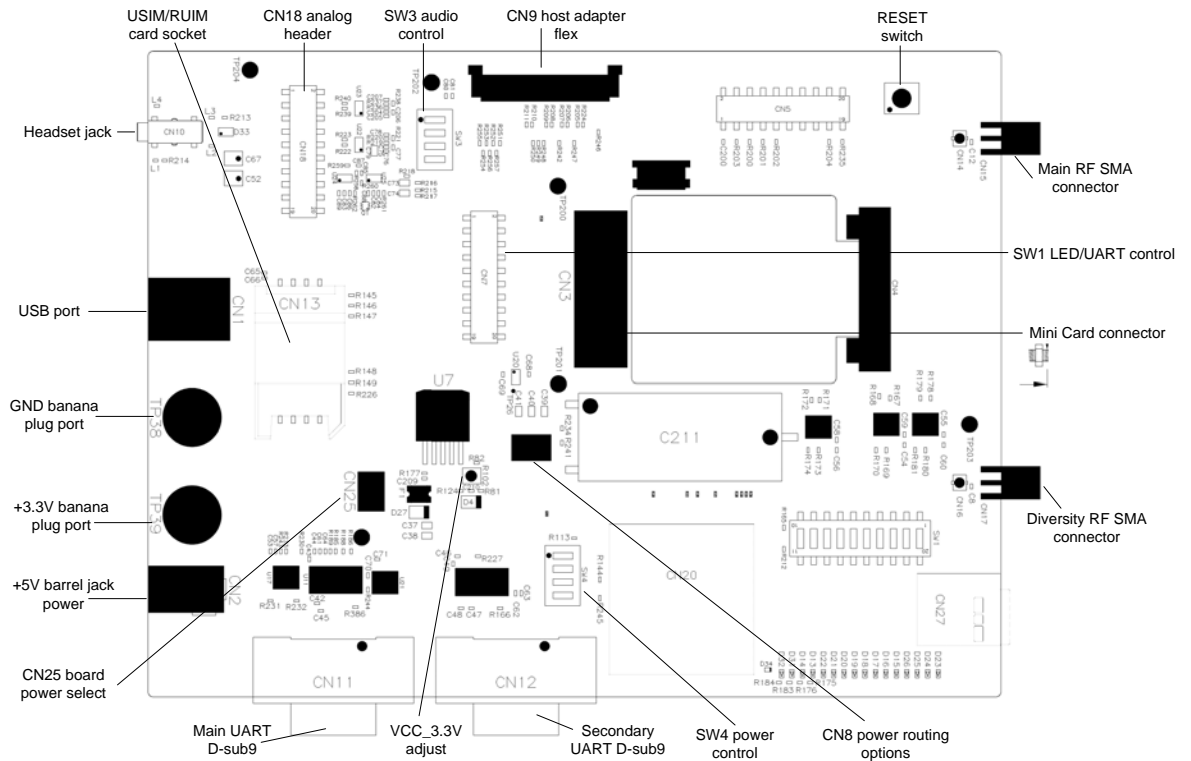

Figure 2-14: Dev kit switches and jumpers

Table 2-1: CN25—Board power (+5 V) select^a

Function	Jump 1-2	Jump 3-4 ^b	Jump 5-6
Power supplied by USB cable (through CN1-USB port)	Yes		
Power supplied from Wall cube brick (through CN2-barrel jack power)			Yes

- a. Required: Select one option only (Jump 1-2 or Jump 5-6)
- b. Pins 3 and 4 are not used

Table 2-2: CN8—Power routing options^{ab}

Function	Jump 1-2	Jump 3-4 ²	Jump 5-6
Enable onboard LDO to supply VCC_3.3V power from USB cable or wall cube (see Table 2-1 on page 19 for details)	Yes		
Host Adapter Flex supplies VCC_3.3V		Yes	
Enable supercapacitor in circuit on VCC_3.3V node (useful for UMTS Mini Cards)			Yes

- a. Required: Select either Jump 1-2 or Jump 3-4
- b. Jump 5-6 is optional—use only as needed

Table 2-3: SW3—Audio control^a

Function	Dip1	Dip2	Dip3	Dip4
+20 dB gain on MIC1P	On		Off	
+0 dB gain on MIC1P	Off		On	
+20 dB gain on MIC1N		On		Off
+0 dB gain on MIC1N		Off		On

a. For line-level audio devices such as TTY consoles, we recommend setting 0 dB MIC gain.

Table 2-4: SW1—LED / UART control

Function / (Label on board)	Dip	On/Off	State
Headset detect (EN HEADSET DET)	1	On	Enable headset detect
		Off	(Default) Disable headset detect
Button detect (EN BUTTON DET)	2	On	Enable button detect
		Off	(Default) Disable button detect
Green LED (EN GRN LED)	3	On	Enable green LED
		Off	(Default) Disable green LED
Red LED (EN RED LED)	4	On	Enable red LED
		Off	(Default) Disable red LED
MIO LEDs (EN MIO LEDS)	5	On	Enable MIO LEDs Enable for voice modems (High = Led ON)
		Off	Disable MIO LEDs Disable for data modems
UART1 flow control (EN UART1 RTS/CTS)	6	On	Enable RTS / CTS lines of UART1 (voice modules can be configured to support this function)
		Off	Disable RTS / CTS lines of UART1
UART1 signals (EN UART1 RI/CD/DTR/DSR)	7	On	Enable CD / DTR / DSR / RI of UART1
		Off	Disable CD / DTR / DSR / RI of UART1
UART1 main transceiver (EN UART1 XCVR)	8	On	Enable UART1 transceiver
		Off	Disable UART1 transceiver
UART3 secondary transceiver (EN UART3 XCVR)	9	On	Enable UART3 transceiver
		Off	Disable UART3 transceiver

Table 2-4: SW1—LED / UART control (Continued)

Function / (Label on board)	Dip	On/Off	State
Disable modem (DISABLE MODEM)	10	On	Disable modem Assert (modem powerdown command)
		Off	Enable modem De-assert (modem power up)

Table 2-5: SW4—Power control

Function	Dip	On / Off	State
VCC_3.3V	1	On	(Default) Fixed regulation from USB power or wall cube power at 3.30 V
		Off	Adjustable regulation from USB power or wall cube power at 3.30 V
	2	On	Enable onboard LDO (Low Drop Out) regulation of power from USB or wall cube
		Off	Disable onboard LDO
VCC_MSM26_DIG^a	3	On	(Default) Supplied by modem
		Off	Not supplied by modem
	4	On	Supplied by Dev Kit
		Off	Not supplied by Dev Kit

Note: Pins 3 and 4 must NOT be ON at the same time.

- a. Required for voice-enabled modems; not required for data modems.
Default setting for non-voice modems is Dip3–On and Dip4–Off.

CN7 - Digital Header

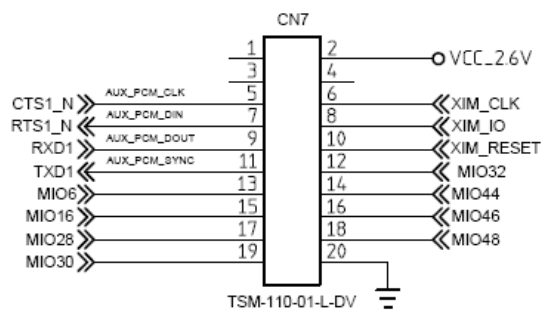

CN18 - Analog header

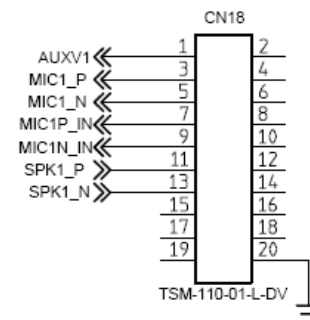

Figure 2-15: Audio test headers

Table 2-6: Dev Kit—Module signal map^a

Pin ^b	MC5727V	MC5728V	MC5727 MC8775 MC8780 MC8781 MC8790 MC8700	MC8201	MC8775V	MC8790V MC8791V MC8792V MC8795V
MIO6	GPIO32	GPIO3	NC	GPIO_1	GPIO_1	GPIO_1
MIO16	GPIO84	GPIO21	NC	GPIO_2	GPIO_2	GPIO_2
MIO28	GPIO85	GPIO20	NC	GPIO_3	GPIO_3	GPIO_3
MIO30	GPIO27	GPIO19	NC	GPIO_4	NC	GPIO_4
MIO32	GPIO26	GPIO18	NC	NC	NC	RI
MIO44	GPIO31	GPIO7	NC	NC	GPIO_4	DCD/GPIO_4
MIO46	GPIO30	GPIO2	NC	NC	GPIO_5	DSR/GPIO_5
MIO48	GPIO18	GPIO15	NC	NC	GPIO_6	DTR/GPIO_6

a. 'GPIO*'—Firmware-assigned signal names.

b. 'MIO'—Multi-purpose I/O. These are the physical pins on the module.

Install / update Mini Card drivers and Watcher

The most recent CDMA and UMTS Mini Card software installation packages (drivers, and Watcher for Windows XP Professional and Windows Vista) are available from www.sierrawireless.com/minicard (registration is required).

If necessary, contact devkit@sierrawireless.com for assistance, or to order the software on CD.

Download CDMA installer package

To download the CDMA Mini Card software installation package:

1. In your browser, go to www.sierrawireless.com/minicard (registration required).
2. Click the **Docs & FW** tab.
3. Click the **EM/MC5xxx CDMA Firmware** link.
4. Click the **Watcher Versions** link.
5. Click the most recent Watcher link.
6. When prompted, save the installer package to a local folder.

Download UMTS installer package

To download the UMTS Mini Card software installation package:

1. In your browser, go to www.sierrawireless.com/minicard (registration required).
2. Click the **Docs & FW** tab.
3. Click the **MC87xx GSM Firmware** link.
4. Click the **3G Watcher and Drivers** link.
5. Click the **3G Watcher Builds** link.
6. Click the link for the most recent Watcher installer package (the File Type is MSI).
7. When prompted, save the installer package to a local folder.

Install CDMA or UMTS software

After downloading the appropriate installer package (CDMA or UMTS):

1. Run the installer package (.msi file). If the InstallShield Wizard window for Watcher appears, go to [Step 2](#). Otherwise, if the Program Maintenance window appears, you have to remove an earlier version of Watcher before continuing:
 - a. Select **Remove** and click **Next**.
 - b. Click **Remove**. A window appears, showing the progress of the uninstall process, and then the InstallShield Wizard window appears when the uninstall is complete.
 - c. Click **Finish**.
 - d. Repeat [Step 1](#) to install the new Watcher software.
2. The InstallShield Wizard Watcher Welcome window appears.
3. Click **Install** (CDMA) or **Next** (UMTS). The License Agreement appears.
4. Read the agreement, and then select **I accept the terms in the license agreement**.
5. Use the default folder (or click **Change** to select a different folder), and then click **Next** (CDMA) or **Install** (UMTS). A window appears, showing the progress of the installation process, and then the installation completed window appears.
6. Click **Finish**.

A: Schematic diagram

Note: [Table 2-6 on page 22](#) provides a cross-reference for signal names that differ between the various modules' product specification documents.

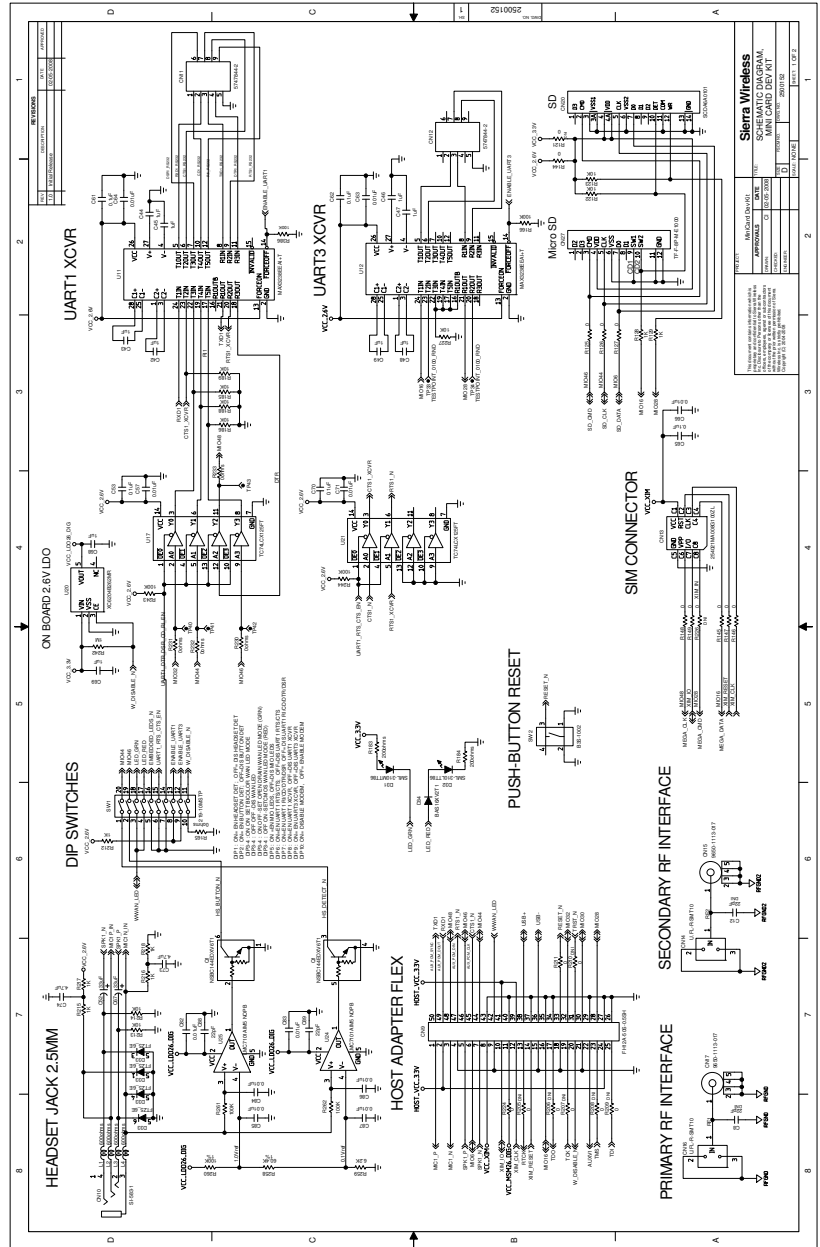

Figure 1-1: Dev Kit schematic diagram (page 1 of 2)

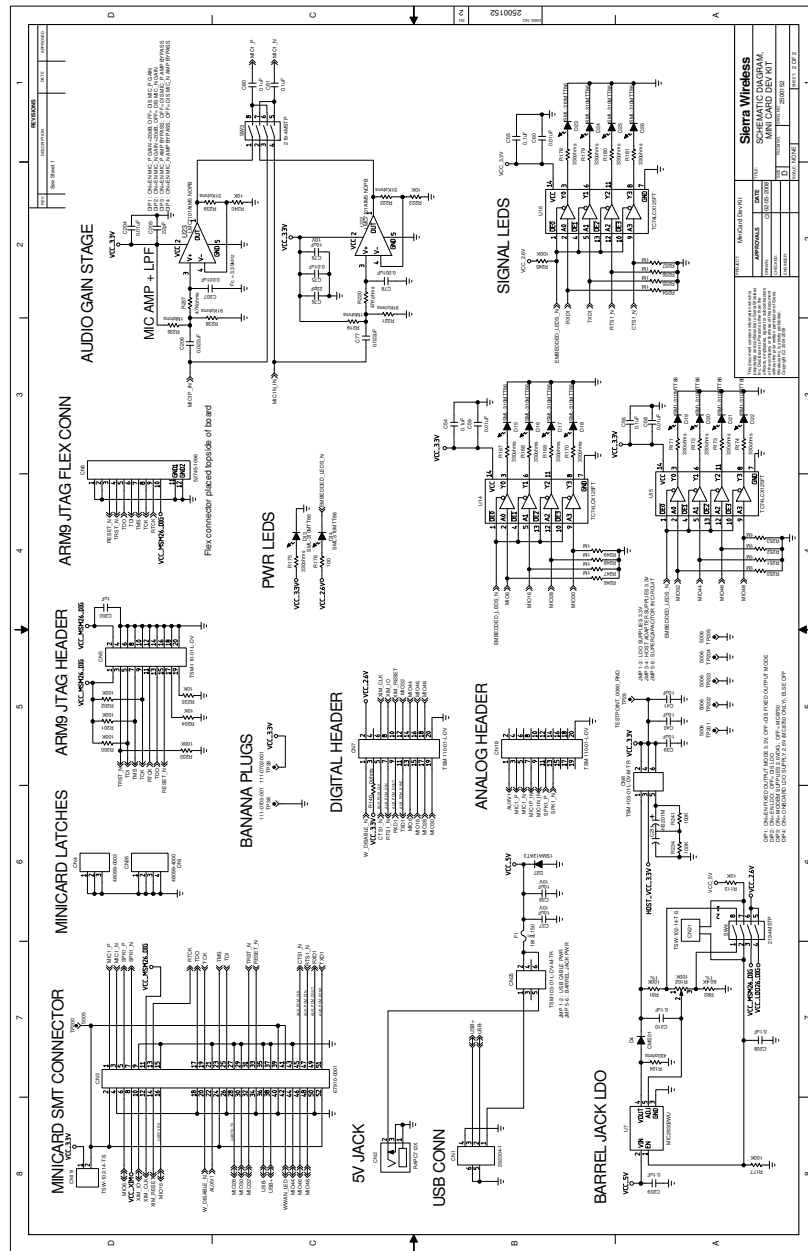

Figure 1-2: Dev Kit schematic diagram (page 2 of 2)

» B: Bill of Materials

B

Table B-1: Development kit bill of materials

Description	Qty	Reference designators	Vendors	Vendor item numbers
CONN,2.5MM,4WIRE AUDIO JACK,RT-ANGLE,SMT	1	CN10	SENIOR INDUSTRIES	SI-583-1
CONNECTOR, ULTRA-MINIATURE, RF, 3.0X3.1mm	2	CN14,CN16	HIROSE	UFL-R-SMT-1(10)
			IPEX	20279-001E-01
CONNECTOR, MINI PCI EXPRESS, 52PIN, 0.8MM, RIGHT ANGLE	1	CN3	MOLEX	67910-0002
ZIF, 10 PIN, 0.5MM, RIGHT ANGLE	1	CN6	MOLEX	52745-1096
CONNECTOR, 6 PIN, 2.54mm DUAL ROW	2	CN8, CN25	SAMTEC	TSM-103-01-L-DV-M-TR
TESTPOINT, COMPACT, THRU-HOLE, RED PLASTIC	1	TP200	KEYSTONE	5005
TESTPOINT, COMPACT, THRU-HOLE, BLACK PLASTIC	5	TP201, TP202, TP203, TP204, TP205	KEYSTONE	5006
HEADER, JTAG, SMT, 20 PIN	3	CN5, CN7, CN18	SAMTEC	TSM-110-01-L-DV
CONNECTOR, RF, EDGE MOUNT, SMA TYPE, 0.062 BOARD THICKNES	2	CN15, CN17	APPLIED ENGINEERING	9650-1113-017
CONNECTOR, 50 PIN, ZIF, 0.5MM, TOP CONTACT TYPE	1	CN9	HIROSE	FH12A-50S-0.5SH(55)
CONNECTOR, 4PIN, USB, THRU, RT ANGLE	1	CN1	TYCO	292304-1
CONNECTOR, 3 PIN, 2.5MM DC POWER JACK	1	CN2	SWITCH CRAFT	RAPC712X
				RAPC712
CONNECTOR, LATCH, MINI PC EXPRESS	1	CN4	MOLEX	48099-0003
BINDING POST, BANANA JACK, VERTICAL, BLACK	1	TP38	JOHNSON COMPONENTS	111-0703-001
			KEYSTONE	7007
BINDING POST, BANANA JACK, VERTICAL, RED	1	TP39	JOHNSON COMPONENTS	111-0702-001
			KEYSTONE	7006
CONNECTOR, RECEPTACLE, D-SUB, 9PIN, RIGHT ANGLE, 0.318 SERIES	2	CN11, CN12	Amp/Tyco	5747844-2

Table B-1: Development kit bill of materials (Continued)

Description	Qty	Reference designators	Vendors	Vendor item numbers
CONNECTOR, SIM, 8 PIN, HINGED, 29.20x17.40x2.3mm	1	CN13	SUYIN	254021MA008G100ZL
CONNECTOR, MicroSD SOCKET, PUSH/PUSH, STANDARD, 14x16x1.88mm	1	CN27	MIT	TF-F-8P-M-E1000
CAP,SUPER,3.6V, 17.5x42MM	1	C211	CAP-XX	HS201K
			CAP-XX	HS201M
			CAP-XX	HS201C
CAP, CER, 10 μ F, 10V,20%, X5R, 0805	6	C37, C38, C39, C40, C41, C79	TAIYO YUDEN	LMK212C106MG
			TAIYO YUDEN	LMK212BJ106KD-T
			MURATA	GRM21BR61A106KE19L
CAP, CER, 1 μ F, 10%, 6.3V, 1005, X5R	11	C42, C43, C44, C45, C46, C47, C48, C49, C68, C69, C200	MURATA	GRM155R60J105KE19D
			TAIYO YUDEN	JMK105BJ105KV-F
CAP, TANT., 33 μ F, 20%, 6.3V, 3528	2	C52, C67	KEMET	T520T336M006ATE070
CAP,CER,4.7 μ F,20%,6.3V,SM,2012, X5R	2	C73, C74	TAIYO YUDEN	CEJMK212BJ475MG-T
CAP,22pF, 50V, \pm 5%, C0G, 1005	4	C76, C88, C89, C205	TAIYO YUDEN	UMK105CG220JV-F
			MURATA	GRM1555C1H220JZ01D
CAP, 1000pF, 50V, \pm 10%, X7R, 1005	2	C78, C207	MURATA	GRM155R71H102KA01D
			TAIYO YUDEN	UMK105BJ102KV-F
CAP, 0.01 μ F, 25V, \pm 10%, X7R, 1005	16	C57, C58, C59, C60, C63, C64, C66, C71, C75, C82, C83, C84, C85, C86, C87, C204	MURATA	GRM155R71E103KA01D
			TAIYO YUDEN	TMK105BJ103KV-F
CAP, 0.022 μ F, 16V, \pm 10%, X7R, 1005	2	C77, C206	MURATA	GRM155R71C223KA01D
			TAIYO YUDEN	EMK105BJ223KV-F

Table B-1: Development kit bill of materials (Continued)

Description	Qty	Reference designators	Vendors	Vendor item numbers
CAP, 0.1 μ F, 10V, \pm 10%, X5R, 1005	13	C53, C54, C55, C56, C61, C62, C65, C70, C80, C81, C208, C209, C210	MURATA	GRM155R61A104KA01D
			TAIYO YUDEN	LMK105BJ104KV-F
RESISTOR, 60.4K, 1%, 1005, 1/16W, 50V, -55 +125C	2	R82, R258	ROHM	MCR01MZPF6042
			KOA SPEER	RK73H1ETTP6042F
			YAGEO	RC0402FR-0760K4L
RES, 100, 5%, 1005, 1/16W, 50V, -55 +125C	1	R176	KOA SPEER	RK73B1ETTP101J
			YAGEO	RC0402JR-07100RL
			ROHM	MCR01MZPJ101
RES, 200, 5%, 1005, 1/16W, 50V, -55 +125C	2	R183, R184	YAGEO	RC0402JR-07200RL
			KOA SPEER	RK73B1ETTP201J
			ROHM	MCR01MZPJ201
RES, 330, 5%, 1005, 1/16W, 50V, -55 +125C	13	R167, R168, R169, R170, R171, R172, R173, R174, R175, R178, R179, R180, R181	YAGEO	RC0402JR-07330RL
			KOA SPEER	RK73B1ETTP331J
			ROHM	MCR01MZPJ331
RES, 430, 5%, 1005, 1/16W, 50V, -55 +125C	1	R124	YAGEO	RC0402JR-07430RL
			KOA SPEER	RK73B1ETTP431J
			ROHM	MCR01MZPJ431
RES, 1.0K, 5%, 1005, 1/16W, 50V, -55 +125C	7	R128, R129, R212, R215, R216, R217, R218	YAGEO	RC0402JR-071KL
			KOA SPEER	RK73B1ETTP102J
			ROHM	MCR01MZPJ102
RES, 6.2K, 5%, 1005, 1/16W, 50V, -55 +125C	1	R259	VISHAY/DALE	CRCW04026K20JNE D
			YAGEO	RC0402JR-076K2L
			KOA SPEER	RK73B1ETTP622J
			ROHM	MCR01MZPJ622

Table B-1: Development kit bill of materials (Continued)

Description	Qty	Reference designators	Vendors	Vendor item numbers
RES, 10K, 5%, 1005, 1/16W, 50V, -55 +125C	14	R113, R122, R123, R185, R186, R188, R189, R204, R213, R214, R223, R227, R235, R240	KOA SPEER	RK73B1ETTP103J
			YAGEO	RC0402JR-0710KL
			ROHM	MCR01MZPJ103
RES, 47K, 5%, 1005, 1/16W, 50V, -55 +125C	2	R220, R237	YAGEO	RC0402JR-0747KL
			KOA SPEER	RK73B1ETTP473J
			ROHM	MCR01MZPJ473
RES, 91K, 5%, 1005, 1/16W, 50V, -55 +125C	4	R221, R22, R238, R239	YAGEO	RC0402JR-0791KL
			KOA SPEER	RK73B1ETTP913J
			ROHM	MCR01MZPJ913
RES, 1.0M, 5%, 1005, 1/16W, 50V, -55 +125C	15	R219, R236, R242, R246, R247, R248, R249, R250, R251, R252, R253, R254, R255, R256, R257	YAGEO	RC0402JR-071ML
			KOA SPEER	RK73B1ETTP105J
			ROHM	MCR01MZPJ105
RES, 0.0 Ohm, 5%, 1005, 1/16W, 50V, -55 +125C	15	R125, R126, R127, R140, R144, R146, R147, R149, R165, R211, R224, R230, R231, R232, R233	KOA SPEER	RK73Z1ETTD
			YAGEO	RC0402JR-070RL
			ROHM	MCR01MZPJ000
RES, POT, 100K, 30%, 0.05W	1	R102	PANASONIC	EVN-5ESX50B15
RES, 100K, 1%, 1005, 1/16W, 50V, -55 +125C	16	R81, R166, R177, R200, R201, R202, R203, R234, R241, R243, R244, R245, R260, R261, R262, R386	YAGEO	RC0402FR-07100KL
			ROHM	MCR01MZPF1003
			KOA SPEER	RK73H1ETTP1003F
IC, BUFFER, QUAD, 5V TOLERANT, TSSOP-14	5	U14, U15, U16, U17, U21	TOSHIBA	TC74LCX125FT(EL)
			ON SEMICONDUCTOR	MC74LCX125DTG
			TOSHIBA	TC74LCX125FT(EL)
IC,LDO,CMOS,LOW NOISE,150mA, 2.6V	1	U20	TOREX	XC6204B262MR

Table B-1: Development kit bill of materials (Continued)

Description	Qty	Reference designators	Vendors	Vendor item numbers
ICS, RS-232 TRANSCEIVER, LOW-POWER, ESD, -40/+85C	2	U11, U12	TEXAS INSTRUMENTS	MAX3238EIDB
			MAXIM	MAX3238EEAI+T
IC, OP-AMP, LOW POWER, RAIL-TO-RAIL, SOT23-5	4	U22, U23, U24, U25	NATIONAL SEMICONDUCTOR	LMC7101AIM5NOPB
IC, LDO, 3A, ADJUSTABLE, TO-263-5	1	U7	MICREL	MIC29302WU
XSTR, DUAL, NPN, 47K OHM BIAS RESISTORS	1	Q1	ON SEMICONDUCTOR	NSBC144EDXV6T1
			ROHM	EMH2
FERRITE BEAD, 600OHM@100MHz, 1005, MULTILAYER	4	L1, L2, L3, L4	TDK	MMZ1005S601CT
			TDK	MMZ1005S601A
			KOA SPEER	CZB1EGTTP601P
			MURATA	BLM15AG601SN1D
			TAIYO YUDEN	BK1005HW601
DIO, BAS16XV2T1, SWITCHING, SOD-523	1	D34	ON SEMICONDUCTOR	BAS16XV2T1G
DIO, SCHOTTKY, 3A, 30V, 3.8x2.4x1.08	1	D4	TOSHIBA	CMS01
LAMP,LED,SMD,1.6x0.8,3.6mcd@20 mA,GRN	15	D13, D14, D15, D16, D17, D18, D19, D20, D21, D22, D23, D24, D25, D26, D31	ROHM	SML-310MTT86
DIODE, ZEN,FTZ5.6, 5.6V/ 5MA,SC-74A	1	D33	ROHM	FTZ5.6ET148
DIODE, TVS, 12V, 400WPEAK, SMA PACKAGE	1	D27	DIODES INC	SMAJ12A-13-F
			ON SEMICONDUCTOR	1SMA12AT3G
LAMP,LED,SMD,1.6x0.8,3.6mcd@20 mA,RED	1	D32	ROHM	SML-310LTT86
FUSE 1.5A, PTC, SLOW-BLOW	1	F1	LITTELFUSE	1812L150
SWITCH, TACT, 4 PIN	1	SW2	OMRON	B3S-1002

Table B-1: Development kit bill of materials (Continued)

Description	Qty	Reference designators	Vendors	Vendor item numbers
SWITCH, DIP, 4-SPST, SEALED, MEDIUM, BLACK BODY	2	SW3, SW4	CTS	219-4MSTP
SWITCH, DIP, 10-SPST, SEALED, MEDIUM, BLACK BODY	1	SW1	CTS	219-10MSTP

